

AMPERE	16			32		
AANTAL POLEN	3	4	5	3	4	5
a Ø	53,0	60,0	66,0	74,5	74,5	74,5
b	104,5	116,5	117,5	137,5	137,5	138,5
c	145,0	157,0	158,0	190,0	190,0	191,0
d	97,5	104,5	105,5	127,5	127,5	128,5
e Ø	18,0	18,0	18,0	23,0	23,0	23,0
f	69,0	79,0	86,0	92,0	92,0	97,0
kabel mm ² min.	1	1	1	2	2,5	2,5
kabel mm ² max.	2,5	2,5	2,5	6	6	6

Koppeling Quick Connect met Multi-Grip

- Schroefloze klemaansluiting
- Vergrendeling van de behuizing middels schroefdraadsluiting
- Kontex-plus
- Met Multi-Grip-kabelwartel
- Spatwaterdicht IP44

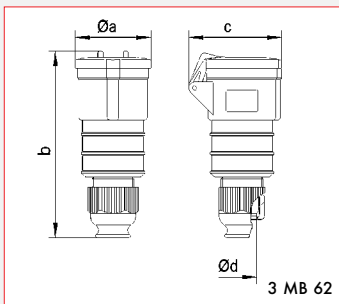

AMPERE	16			32		
AANTAL POLEN	3	4	5	3	4	5
a Ø	51,0	58,0	65,0	66,5	66,5	72,0
b	156,0	162,0	168,0	195,0	195,0	198,0
c	72,0	78,0	86,0	89,0	89,0	99,0
d Ø	18,0	18,0	21,0	23,0	23,0	27,0
kabel mm ² min.	1	1	1	2,5	2,5	2,5
kabel mm ² max.	2,5	2,5	2,5	6	6	6

QUICK CONNECT®

Koppeling TE-Plus met Multi-Grip

- Schroefloze klemaansluiting
- Hittebestendige contactdragers
- Kontex-plus
- vernikkelde contacten
- Met Multi-Grip-kabelwartel
- Spatwaterdicht IP44

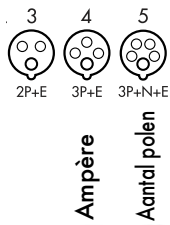

110V 50-60 Hz			230V 50-60 Hz			400V 50-60 Hz			500V 50-60 Hz			100-300 Hz > 50V			301-500 Hz > 50V		
3pol 4h	4pol 4h	5pol 4h	3pol 6h	4pol 9h	5pol 9h	3pol 9h	4pol 6h	5pol 6h	3pol 7h	4pol 7h	5pol 7h	3pol 10h	4pol 10h	5pol 10h	3pol 2h	4pol 2h	5pol 2h

Verp.
eenh. Gewicht

G/
stuk

 TYP 31 36	16	3	31 25	31 26											10	145
	16	4		31 29	31 30				31 32						10	175
	16	5		31 35	31 36										10	200
	32	3	31 37	31 38											10	265
	32	4		31 41	31 42										10	285
	32	5			31 48										10	330

 TYP 31 536	16	3	31 659	31 533	31 665	31 955	31 956	31 957	10	155
	16	4	31 681	31 661	31 534	31 959	31 669	31 671	10	195
	16	5	31 962	31 662	31 536	31 964	31 965	31 966	10	225
	32	3	31 967	31 968	31 666	31 970	31 971	31 972	10	290
	32	4	31 973	31 974	31 975	31 976	31 670	31 672	10	310
	32	5	31 979	31 664	31 981	31 884	31 983	31 984	10	350

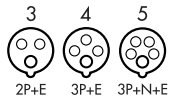

Ampère

Aantal polen

110V 50-60 Hz			230V 50-60 Hz			400V 50-60 Hz			500V 50-60 Hz			100-300 Hz > 50V			301-500 Hz > 50V		
3pol 4h	4pol 4h	5pol 4h	3pol 6h	4pol 9h	5pol 9h	3pol 9h	4pol 6h	5pol 6h	3pol 7h	4pol 7h	5pol 7h	3pol 10h	4pol 10h	5pol 10h	3pol 2h	4pol 2h	5pol 2h

Verp.
eenh. Gewicht

G/
stuk

	16	3	31 298	31 240	31 299	31 457									10	195
	16	4	31 301	31 302	31 241	31 242	31 303	31 304							10	230
	16	5	31 305	31 306	31 243	31 501		31 409							10	265
	32	3	31 307	31 244	31 308										10	355
	32	4	31 309	31 310	31 245	31 246	31 311	31 312							10	375
	32	5	31 313	31 314	31 247	31 207									10	420

	63	4			310 491	310 493									5	785
	63	5			310 495										5	830

Wanneer pilotcontact gewenst dan artnr. + P bestellen.

	63	3	31 80	31 81	31 82	31 724	31 605								5	725
	63	4	31 83	31 84	31 85	31 86	31 504	31 251							5	785
	63	5	31 87	31 88	31 24	31 082	31 505	31 183							5	830

Wanneer pilotcontact gewenst dan artnr. + P bestellen.

	125	3	31 90	31 91	31 92										5	1130
	125	4	31 93	31 94	31 95	31 96	31 611								5	1230
	125	5	31 97	31 98	31 99	31 417									5	1350

Wanneer pilotcontact gewenst dan artnr. + P bestellen.