

230 V
50 - 60 Hz

400 V
50 - 60 Hz

Verpakte
inhoud

Gewicht

4pol 5pol
9h 9h

4pol 5pol
6h 6h

G/
stuk

TK-COMBINATIE CONTACTDOZEN

IEC 309, EN 60309, VDE 0620 beschermingsfactor IP44
Schukocontactdozen ook in Belgische/Franse uitvoering leverbaar



TYPE 10 10

TK-combinatie contactdoos

- Met klemmen, met bedrading (aansluitklaar voorbereid)
- Met ingebouwde schuko-contactdoos 16A/230V
- Spatwaterdicht IP44

Ampère	Aantal polen	4pol 9h	5pol 9h	4pol 6h	5pol 6h	Verpakte inhoud	Gewicht
16	4	10 13				10	510
16	5			10 10		10	520



TYPE 10 11

TK-combinatie contactdoos

- Met klemmen, met bedrading (aansluitklaar voorbereid)
- Met zekeringhouder 5 x 20 mm DIN 41671
- Met ingebouwde schuko-contactdoos 16A/230v
- Spatwaterdicht IP44

2) 2 x zekeringhouder

Ampère	Aantal polen	4pol 9h	5pol 9h	4pol 6h	5pol 6h	Verpakte inhoud	Gewicht
16	5			10 9		10	580
32	4 ²⁾	10 20 ²⁾				10	600
32	5			10 11		10	610



TYPE 10 18

TK-combinatie contactdoos

- Belgisch/Franse uitvoering
- Met klemmen, met bedrading (aansluitklaar voorbereid)
- Met zekeringhouder 5 x 20 mm DIN 41671
- Spatwaterdicht IP44

2) 2 x zekeringhouder

Ampère	Aantal polen	4pol 9h	5pol 9h	4pol 6h	5pol 6h	Verpakte inhoud	Gewicht
16	4 ²⁾	10 17 ²⁾				10	560
16	5			10 15		10	570
32	4 ²⁾	10 19 ²⁾				10	590
32	5			10 18		10	600

DRAAIVELDRICHTINGAANWIJZER ADAPTER-STEKER HAAKSE STEKER



230 V 50-60 Hz		400 V 50-60 Hz		500 V 50-60 Hz	
4pol 9h	5pol 9h	4pol 6h	5pol 6h	4pol 7h	5pol 7h

Verpakte
inhoud

Gewicht

G/
stuk



Draaiveldrichtingaanwijzer

Draaiveldrichtingaanwijzer voor
container-dozen zie blz. 56

16	4	22 10	22 11	22 12	1	170
16	5	22 13	22 14	22 15	1	195
32	4	22 16	22 17	22 18	1	265
32	5	22 19	22 20	22 21	1	290
63	4	22 22	22 23	22 24	1	600
63	5	22 25	22 26	22 27	1	650



Draaiveldrichtingaanwijzer

»Tripol« 400/230 V

- Met ingebouwde schuko-contactdoos
- Ingebouwde elektronica voor:
 - draaiveldaanwijzer
 - aansluiting van meetapparatuur
 - fasenaanwijzer

16	5		22 34		1	300
32	5		22 35		1	450
63	5		22 36		1	775



Draaiveldrichtingaanwijzer

- zonder onverwisselb. positioneringsnok
- Voor alle bedrijfsspanningen tussen 230 / 600V

16	4		22 28		1	170
16	5		22 29		1	195
32	4		22 30		1	265
32	5		22 31		1	290
63	4		22 32		1	600
63	5		22 33		1	650



Adapter - steker

CEE-steker 16A/230V 3P op
schuko-contactdoos 16A/230V~

86 15

CEE-steker 16A/230V/3P op
schuko-contactdoos 16A/230V~ Belgisch/Franse uitvoering

86 14

CEE-steker 16A/230V/3P op
schuko-contactdoos 16A/230V~ Zwitserse uitvoering (type 13)

86 18

Verdere adapter uitvoeringen op aanvraag

PSK, HKS & 7-POL

TECHNISCHE INFORMATIE

PSK - potentiaal vrij - contact

- Potentiaal vrij schakeling van de ingebouwde hulpcontacten in pilotbus van de contactdoos (63A & 125A).
- Bestemd voor veiligheidsvergrendeling of voor aanvullende stuurdoelen.



Conventionele vergrendeling

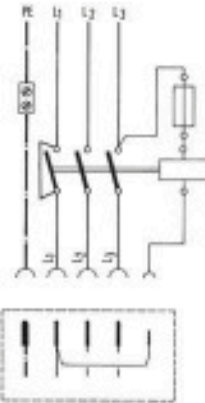

PSK - vergrendeling

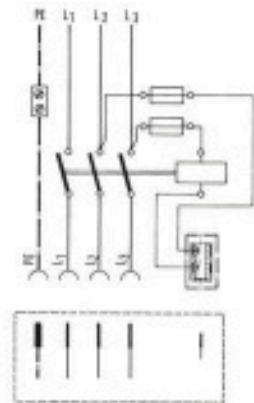

HKS inbouwcontactdoos

- Hulp-contactschakelaar veelzijdig toe te passen: controleren, aansturen, regelen, bewaken.
- aanvullende hulp-contactschakelaar en inbouwdozen (schuko 16A/32A CEE-contactdoos) sluit- en/of doorsteker.
- Elektrische steker-vergrendeling.
- Potentieelvrij schakelen
- Schakelement, b.v. beveiliging kan er apart ingezet worden.

7-polige contactmaterialen 16A & 32A

- Ondubbelzinnige voordelen in de bereiken (omkeer) schakeling / ster / drie-hoekschakeling / Amp. schakeling / regeltechniek / elektrische vergrendeling / bewaking / voldoening / melding.

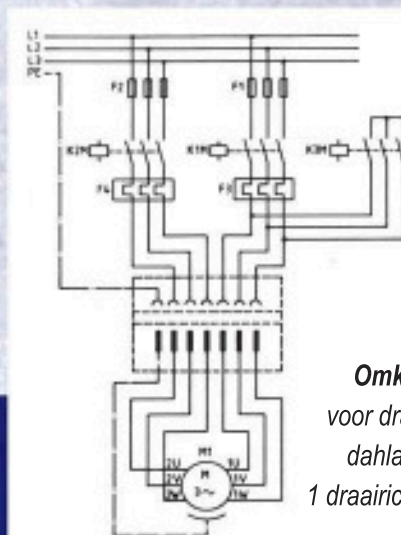

Omkeerschakeling
voor draaistroommotoren
dahlander schakeling
1 draairichting, 2 toerentallen

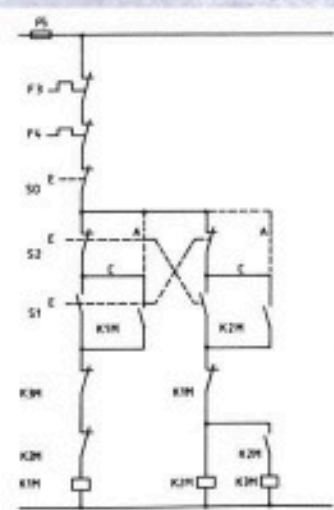

net beveiliging, lage toerentallen net beveiliging, hoge toerentallen ster beveiliging, hoge toerentallen

CONTACTMATERIALEN

Met elektrische PSK-vergrendeling,
IEC 309, EN 60309, VDE 0623

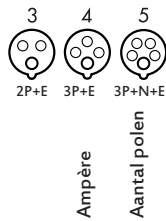

110V 50-60 Hz			230V 50-60 Hz			400V 50-60 Hz			500V 50-60 Hz		
3pol 4h	4pol 4h	5pol 4h	3pol 6h	4pol 9h	5pol 9h	3pol 9h	4pol 6h	5pol 6h	3pol 7h	4pol 7h	5pol 7h

Verpakte inhoud
Gewicht
g/
Stuks Stuks

TYPE 16 072	Wandcontactdoos	<ul style="list-style-type: none"> Met elektrische PSK-vergrendeling en beveiliging (Kloeckner Moeller DIL 2m) Kontex -plus Raamklemmen Waterdicht IP67 	110V			230V			400V			500V		
			3pol	4pol	5pol	3pol	4pol	5pol	3pol	4pol	5pol	3pol	4pol	5pol
	63* 4							16 070	16 071				1 2800	
	63* 5							16 072					1 2850	
	Andere beveiligings-fabrikaten op aanvraag													

TYPE 16 76	Wandcontactdoos	<ul style="list-style-type: none"> Met elektrische PSK-vergrendeling en beveiliging (Kloeckner Moeller DIL 4m) Kontex-plus Raamklemmen Waterdicht IP67 	110V			230V			400V			500V		
			3pol	4pol	5pol	3pol	4pol	5pol	3pol	4pol	5pol	3pol	4pol	5pol
	125 4							16 74	16 75				1 8050	
	125 5							16 76					1 8200	
	Andere beveiligings-fabrikaten op aanvraag													

TYPE 12 020	Inbouwcontactdoos	<ul style="list-style-type: none"> Hoek 15° Flens: 114 x 114 mm Boorgat afst.: 90 x 90 mm Met PSK-vergrendeling Kontex-plus Raamklemmen Waterdicht IP67 Tekening 63A, 125A Zie blz. 24 / 4 MB 9 	110V			230V			400V			500V		
			3pol	4pol	5pol	3pol	4pol	5pol	3pol	4pol	5pol	3pol	4pol	5pol
	63* 4							12 052	12 053				5 760	
	63* 5							12 020					5 820	
	125 4							12 139	12 054				5 1230	
	125 5							12 025					5 1350	

TYPE 130 524	Inbouwcontactdoos	<ul style="list-style-type: none"> Recht Met sluitcontact Flens 75 x 75 mm Boorgat afst. 60 x 60 mm Maximale inbouwdiepte 54 mm Hittebestendige contactdragers Vernikkelde contacten Spatwaterdicht IP44 	110V			230V			400V			500V		
			3pol	4pol	5pol	3pol	4pol	5pol	3pol	4pol	5pol	3pol	4pol	5pol
	16* 3		130 520	130 521										
	16* 4							130 522	130 523					
	16* 5							130 524						
	32* 3		130 525	130 526										
	32* 4							130 527	130 528					
	32* 5							130 529						

TYPE 120 587	Inbouwcontactdoos	<ul style="list-style-type: none"> Hoek Met sluitcontact Flens 70 x 70 mm Boorgat afst. 70 x 70 mm Maximale inbouwdiepte 61 mm Hittebestendige contactdragers Vernikkelde Contacten Spatwaterdicht IP44 	110V			230V			400V			500V		
			3pol	4pol	5pol	3pol	4pol	5pol	3pol	4pol	5pol	3pol	4pol	5pol
	16* 3		120 583	120 584										
	16* 4							120 585	120 586					
	16* 5							120 587						
	32* 3		120 588	120 589										
	32* 4							120 590	120 591					
	32* 5							120 592						

* 16/32A leverbaar in IP44, IP55, IP67 en 63A in IP44, IP67

CONTACTMATERIALEN 7-POLIG (6P + E)

Hittebestendige contactdragers en vernikkelde contacten voor contactverbindingen: Ompoolschakeling/ster-driehoek-schakeling/amp.schakeling, beschermingsfactor IP44, IP67

Ampère	Aantal polen 6P+E	Verpakte inhoud		Gewicht	
		230 V 50 - 60 Hz	400 V 50 - 60 Hz		
		7pol 9h	7pol 6h	Stuks	g/ Stuks

 <p>TYPE 11 481</p>	Wandcontactdoos <ul style="list-style-type: none"> ● Kabelinvoer eenmaal boven (open), tweemaal onder (gesloten) ● Behuizingsonderdeel 180° draaibaar ● 4 bevestigings boorgaten in de onderkant v/d behuizingsbodem ● Spatwaterdicht IP44 Tekening zie blz. 14 / 1 MB 2 (onder 5-pol)		16	7	11 480	11 481	10	320
	<ul style="list-style-type: none"> ● Ook in IP67 leverbaar 		32	7	11 482	11 483	10	440

 <p>TYPE 13 329</p>	Inbouwcontactdoos recht <ul style="list-style-type: none"> ● Flens 75 x 75 mm ● Spatwaterdicht IP44 Tekening zie blz. 18 / 4 MB 99 (onder 5-pol)		16	7	13 326	13 327	10	185
	<ul style="list-style-type: none"> ● Ook in IP67 leverbaar 		32	7	13 328	13 329	10	245

 <p>TYP 21 0067</p>	Steker met Multi-Grip <ul style="list-style-type: none"> ● Met Multi-Grip-kabelwartel ● Spatwaterdicht IP44 ● Waterdicht IP67 		16	7	21 0550	21 557	10	275
			32	7	21 0636	21 0067	10	370
			16	7	21 711	21 667	10	265
			32	7	21 712	21 669	10	405

 <p>TYP 31 0123</p>	Koppeling met Multi-Grip <ul style="list-style-type: none"> ● Met Multi-Grip-kabelwartel ● Spatwaterdicht IP44 ● Waterdicht IP67 		16	7	31 0311	31 752	10	275
			32	7	31 0381	31 0123	10	430
			16	7	31 512	31 513	10	310
			32	7	31 514	31 515	10	480

 <p>TYPE 16 379</p>	Wandcontactdoos <ul style="list-style-type: none"> ● Afschakelbaar ● Met mechanisch dubbel vergrendeling ● In 0-positie afsluitbaar ● Spatwaterdicht IP44 Tekening zie blz. 42 / 12 MB 24 (onder 5-pol)		16	7	16 445	16 378	1	1170
	<ul style="list-style-type: none"> ● Ook in IP 67 leverbaar 		32	7	16 446	16 379	1	1300

ACCESSOIRES

Klapvenster, zelfsluitend, transparant, IP44, met kartel schroeven, IP67, afsluitbaar en /of verzegelbaar uit hoogwaardige, slagvaste kunststof.

Deleenheden	Afmeting		Bestelnr.
	a	b	



Klapvenster
 ● Zelfsluitend
 ● Aanrakingsveilig

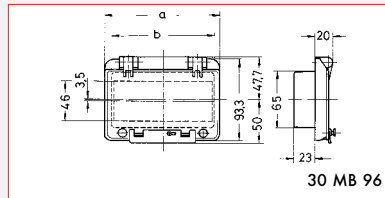

2	55,0	40,5	58 81
4	91,0	76,5	58 90
6	127,0	112,5	58 99
8	162,0	147,5	58 009
12	234,0	220,0	58 018
13	257,5	248,5	58 027



Klapvenster
 ● Zelfsluitend
 ● niet aanrakingsveilig

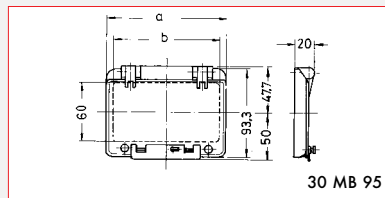

2	55,0	37,0	58 82
4	91,0	73,0	58 91
6	127,0	109,0	58 001
8	162,0	144,5	58 010
12	234,0	217,0	58 019
13	257,5	240,0	58 028



Klapvenster
 ● Zelfsluitend
 ● Aanrakingsveilig en met montagerail

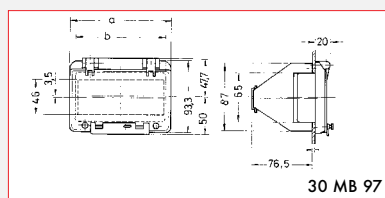

2	55,0	40,5	58 85
4	91,0	76,5	58 94
6	127,0	112,5	58 004
8	162,0	147,5	58 013
2	234,0	220,0	58 022
3	257,5	248,5	58 031